

# Type 107 Electrically Actuated Ball Valve

## Standard Features

- **Size**  
3/8" - 2"
- **Voltage**  
24 AC or DC  
110-230 AC
- **Emergency Manual Override**
- **Material**  
PVC, CPVC
- **Connection Ends**  
Socket, Flanged, Threaded NPT
- **Seat**  
PTFE
- **Seals**  
EPDM or FPM
- **Mounting**  
Stainless steel threaded inserts  
for easy and secure mounting
- **Duty Cycle**  
40%

## Optional Features

- **Pneumatic Actuation**
- **Limit Switches**
- **Fail Safe Return**  
Back up battery pack
- **Heating Element**



## General

Available in PVC and CPVC, the type 107 ball valve is ideal for a variety of applications. The type 107 valve is a perfect fit where simple open/close operation is required. It operates on either AC or DC voltage and has the option for position signalization limit switches. Included with each valve are NPT and Socket end connectors. Manual versions can easily be retrofitted in the field.

# Technical specifications Electric actuator 11



CE	✓
SP	✓
UL US	✓

EA 11	
Nominal torque Mdn	10 Nm
Peak torque	20Nm
Control time	5 s/ 90° at Mdn
Actuating angle	max. 180°, set to 90°
L/W/H	129/122/138
Cycles at 70°F and Mdn	150,000
Flanges	F05
Housing materials	PP fiberglass reinforced, flame retardant, external stainless steel screws
Position indicator	optical, integrated
Emergency manual override	integrated
Rated voltage	100- 230V, 50/60 Hz 24V = /24V, 50/60 Hz
Rated voltage tolerance	+/- 10%
Rated output	28 Watts
Direct impedance	230V, 100k 24V, 4k7
Duty cycle ED	40% at 77°F/15 min
Protection class	IP 65 per EN 60529 [3] UL/CSA: for interior use
Overload protection	current / time dependent (resetting) [1]
Overvoltage category [5]	II
Electrical connections	Connector plug 3 P+ E per DIN EN 175301-03 (formerly DIN 43650), additional cable entry point for PG11
Pollution grade [5]	2
Height over NN (UL/CSA)	< 2000m
Ambient temperature	14° to + 110°F [2]
Allowable humidity	max. 80% to 88°F [4]

[1] Overload protection of the motor is dimensioned so that the motor and the power supply board are protected. As soon as the load is in the torque range, the actuator runs again.

[2] At temperatures below 14°F and if there is condensation, the heating element no. 198 190 086 should be built in.

[3] Protection class IP67 for use of cable glands and vertical installation.

[4] Linear decrease up to 50% relative humidity at 104°F.

[5] According to DIN EN 61010-1

# Technical Data

## Pressure-Temperature Diagrams Technical data for Type 107 Ball Valves 3/8"-2"

The following pressure temperature diagrams are based on a lifetime of 25 years and the medium water or similar media

### PVC

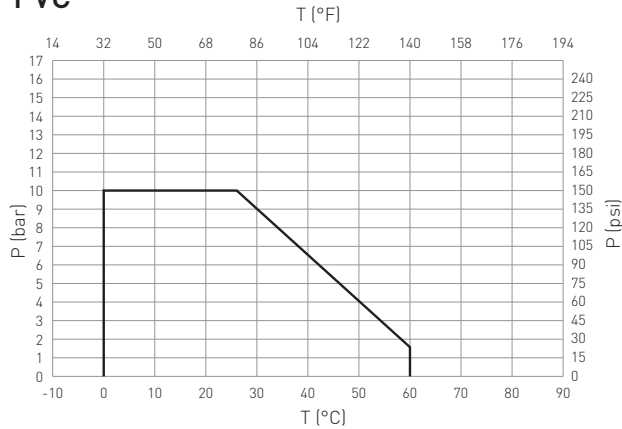

### CPVC

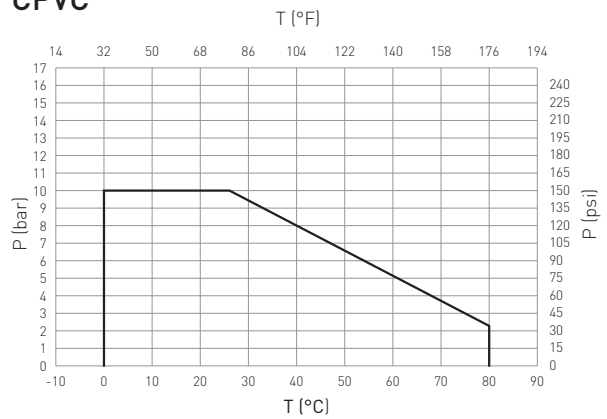

### Operating Torque

Average values at nominal pressure

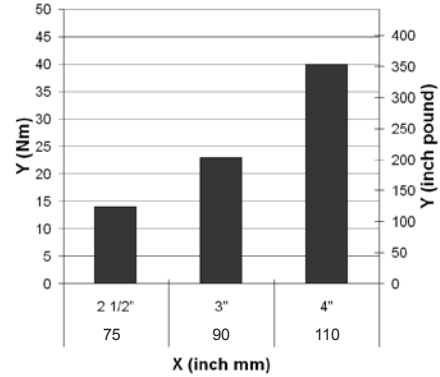
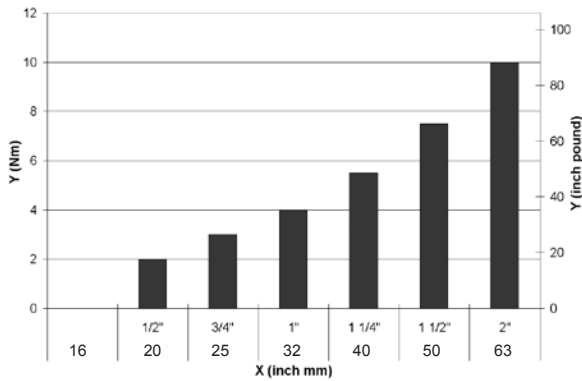

X Size (mm, inch) Y Torque (Nm, inch pound)

### Pressure loss

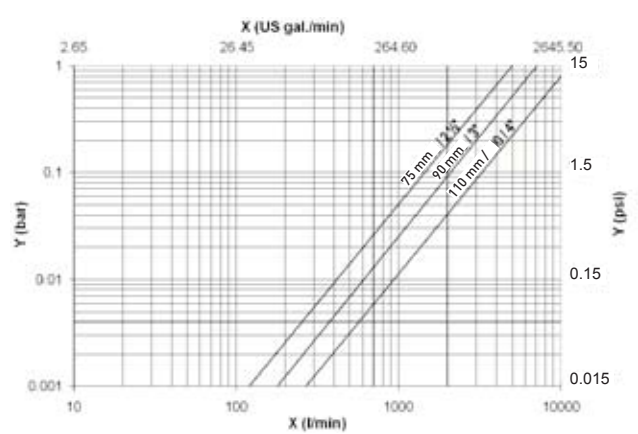
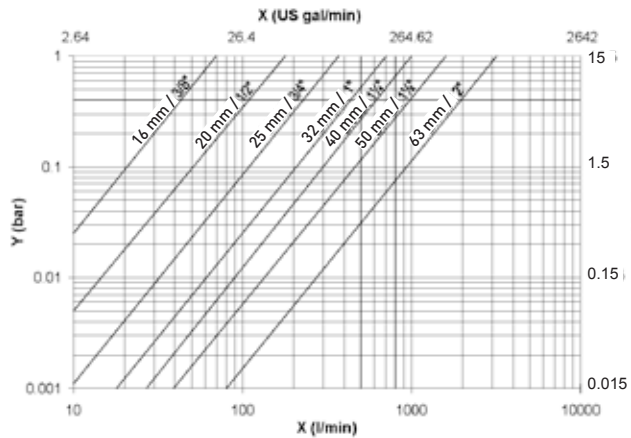

Medium: water, 20°C

X Flow rate (l/min / U.S. gal/min) Y Pressure loss  $\Delta p$  (bar / psi)

# PVC

## Type 107 Electrically Actuated Ball Valve

With manual emergency override

With solvent cement sockets inch ASTM/threaded NPT

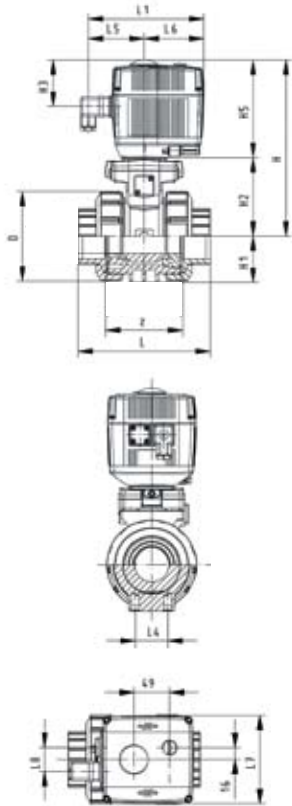

Inch	Cv-value [gal/min]	psi		D [mm]	H [mm]	H1 [mm]	H2 [mm]	H3 [mm]	H5 [mm]
		socket	NPT						
3/8	4.9	150	150	50	200	27	64	64	137
1/2	12.9	150	150	50	200	27	64	64	137
3/4	24.5	150	150	58	209	30	73	64	137
1	49.0	150	150	68	209	36	73	64	137
1 1/4	70.0	150	150	84	220	44	84	64	137
1 1/2	112.0	150	150	97	220	51	84	64	137
2	217.1	150	150	124	243	64	106	64	137

Sockets	L [mm]	L1 [mm]	L4 [mm]	L5 [mm]	L6 [mm]	L7 [mm]	L8 [mm]	z [mm]
	NPT							
105	98	161	25	79	83	122	67	67
105	98	161	25	79	83	122	67	61
121	111	161	25	79	83	122	67	70
133	127	161	25	79	83	122	67	76
154	147	161	45	79	83	122	67	90
164	157	161	45	79	83	122	67	94
183	183	161	45	79	83	122	67	107

## With flanges, ANSI

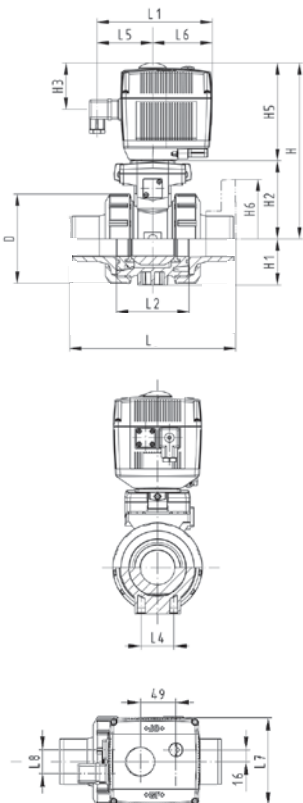

Inch	psi	Cv-value [gal/min]	D [mm]	H [mm]	H1 [mm]	H2 [mm]	H3 [mm]	H5 [mm]	L [mm]
1/2	150	12.9	50	200	27	64	64	137	149
3/4	150	24.5	58	209	30	73	64	137	165
1	150	49.0	68	209	36	73	64	137	184
1 1/4	150	70.0	84	220	44	84	64	137	206
1 1/2	150	112.0	97	220	51	84	64	137	221
2	150	217.0	124	243	64	106	64	137	251

L1 [mm]	L2 [mm]	L4 [mm]	L5 [mm]	L6 [mm]	L7 [mm]	L8 [mm]
161	56	25	77	83	122	33
161	65	25	77	83	122	33
161	71	25	77	83	122	33
161	85	45	77	83	122	33
161	89	45	77	83	122	33
161	101	45	77	83	122	33

# CPVC

## Type 107 Electrically Actuated Ball Valve

With solvent cement sockets inch ASTM/threaded NPT

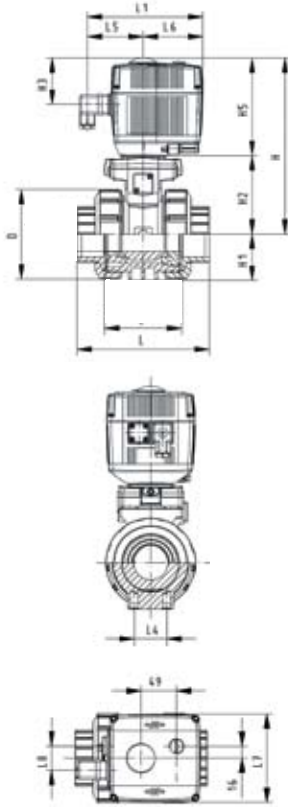

Inch	Cv-value [gal/min]	psi		D [mm]	H [mm]	H1 [mm]	H2 [mm]	H3 [mm]	H5 [mm]
		socket	NPT						
3/8	4.9	150	150	50	200	27	64	64	137
1/2	12.9	150	150	50	200	27	64	64	137
3/4	24.5	150	150	58	209	30	73	64	137
1	49.0	150	150	68	209	36	73	64	137
1 1/4	70.0	150	150	84	220	44	84	64	137
1 1/2	112.0	150	150	97	220	51	84	64	137
2	217.1	150	150	124	243	64	106	64	137

Socket	L [mm]	L1 [mm]	L4 [mm]	L5 [mm]	L6 [mm]	L7 [mm]	L8 [mm]	z [mm]
	NPT							
105	98	161	25	79	83	122	67	67
105	98	161	25	79	83	122	67	61
121	111	161	25	79	83	122	67	70
133	127	161	25	79	83	122	67	76
154	147	161	45	79	83	122	67	90
164	157	161	45	79	83	122	67	94
183	183	161	45	79	83	122	67	107

# GF Piping Systems → worldwide at home

Our sales companies and representatives ensure local customer support in over 100 countries.

[www.piping.georgfischer.com](http://www.piping.georgfischer.com)



The technical data is not binding. They neither constitute expressly warranted characteristics nor guaranteed properties nor a guaranteed durability. They are subject to modification. Our General Terms of Sale apply.

## Adding Quality to People's Lives

### Australia

Georg Fischer Pty Ltd  
Riverwood NSW 2210 Australia  
Phone +61(0)2 9502 8000  
[australia.ps@georgfischer.com](mailto:australia.ps@georgfischer.com)  
[www.georgfischer.com.au](http://www.georgfischer.com.au)

### Austria

Georg Fischer  
Rohrleitungssysteme GmbH  
3130 Herzogenburg  
Phone +43(0)2782 856 43-0  
[austria.ps@georgfischer.com](mailto:austria.ps@georgfischer.com)  
[www.georgfischer.at](http://www.georgfischer.at)

### Belgium/Luxembourg

Georg Fischer NV/SA  
1070 Bruxelles/Brüssel  
Phone +32(0)2 556 40 20  
[be.ps@georgfischer.com](mailto:be.ps@georgfischer.com)  
[www.georgfischer.be](http://www.georgfischer.be)

### Brazil

Georg Fischer Ltda  
04795-100 São Paulo  
Phone +55(0)11 5687 1311  
[br.ps@georgfischer.com](mailto:br.ps@georgfischer.com)

### Canada

Georg Fischer Piping Systems Ltd  
Brampton, ON L6T 4E3  
Phone +1(905) 792-8005  
[ca.ps@georgfischer.com](mailto:ca.ps@georgfischer.com)  
[www.gfipiping.ca](http://www.gfipiping.ca)

### China

Georg Fischer  
Piping Systems Ltd Shanghai  
Pudong, Shanghai 201319  
Phone +86(0)21 58 13 33 33  
[china.ps@georgfischer.com](mailto:china.ps@georgfischer.com)  
[www.cn.piping.georgfischer.com](http://www.cn.piping.georgfischer.com)

### Denmark/Iceland

Georg Fischer A/S  
2630 Taastrup  
Phone +45 (0)70 22 19 75  
[info.dk.ps@georgfischer.com](mailto:info.dk.ps@georgfischer.com)  
[www.georgfischer.dk](http://www.georgfischer.dk)

### France

Georg Fischer SAS  
95932 Roissy Charles de Gaulle Cedex  
Phone +33(0)1 41 84 68 84  
[fr.ps@georgfischer.com](mailto:fr.ps@georgfischer.com)  
[www.georgfischer.fr](http://www.georgfischer.fr)

### Germany

Georg Fischer GmbH  
73095 Albershausen  
Phone +49(0)7161 302-0  
[info.de.ps@georgfischer.com](mailto:info.de.ps@georgfischer.com)  
[www.georgfischer.de](http://www.georgfischer.de)

### India

Georg Fischer Piping Systems Ltd  
400 076 Mumbai  
Phone +91 224007 2001  
[in.ps@georgfischer.com](mailto:in.ps@georgfischer.com)  
[www.georgfischer.in](http://www.georgfischer.in)

### Italy

Georg Fischer S.p.A.  
20063 Cernusco S/N (MI)  
Phone +3902 921 861  
[it.ps@georgfischer.com](mailto:it.ps@georgfischer.com)  
[www.georgfischer.it](http://www.georgfischer.it)

### Japan

Georg Fischer Ltd  
556-0011 Osaka  
Phone +81(0)6 6635 2691  
[jp.ps@georgfischer.com](mailto:jp.ps@georgfischer.com)  
[www.georgfischer.jp](http://www.georgfischer.jp)

### Korea

Georg Fischer Piping Systems  
Guro-3 dong, Guro-gu, Seoul, Korea  
Phone +82(0)2 2081 1450  
Fax +82(0)2 2081 1453  
[kor.ps@georgfischer.com](mailto:kor.ps@georgfischer.com)

### Malaysia

Georg Fischer (M) Sdn. Bhd.  
40460 Shah Alam, Selangor  
Phone +60 (0)3 5122 5585  
[conne.kong@georgfischer.com](mailto:conne.kong@georgfischer.com)

### Mexico

Georg Fischer S.A. de C.V.  
Apodaca, Nuevo Leon  
CP66636 Mexico  
Phone +52 (81)1340 8586  
Fax +52 (81)1522 8906

### Middle East

Georg Fischer Piping Systems  
Dubai, United Arab Emirates  
Phone +971 4 289 49 60  
[info.export@georgfischer.com](mailto:info.export@georgfischer.com)  
[www.export.georgfischer.com](http://www.export.georgfischer.com)

### Netherlands

Georg Fischer N.V.  
8161 PA Epe  
Phone +31(0)578 678 222  
[nL.ps@georgfischer.com](mailto:nL.ps@georgfischer.com)  
[www.georgfischer.nl](http://www.georgfischer.nl)

### Norway

Georg Fischer AS  
1351 Rud  
Phone +47(0)67 18 29 00  
[no.ps@georgfischer.com](mailto:no.ps@georgfischer.com)  
[www.georgfischer.no](http://www.georgfischer.no)

### Poland

Georg Fischer Sp. z o.o.  
02-226 Warszawa  
Phone +48(0)22 313 10 50  
[poland.ps@georgfischer.com](mailto:poland.ps@georgfischer.com)  
[www.georgfischer.pl](http://www.georgfischer.pl)

### Romania

Georg Fischer  
Piping Systems Ltd  
020257 Bucharest - Sector 2  
Phone +40(0)21 230 53 80  
[ro.ps@georgfischer.com](mailto:ro.ps@georgfischer.com)  
[www.export.georgfischer.com](http://www.export.georgfischer.com)

### Russia

Georg Fischer Piping Systems  
Moscow 125047  
Tel. +7 495 258 60 80  
[ru.ps@georgfischer.com](mailto:ru.ps@georgfischer.com)  
[www.georgfischer.ru](http://www.georgfischer.ru)

### Singapore

Georg Fischer Pte Ltd  
528 872 Singapore  
Phone +65(0)67 47 06 11  
[sgp.ps@georgfischer.com](mailto:sgp.ps@georgfischer.com)  
[www.georgfischer.com.sg](http://www.georgfischer.com.sg)

### Spain/Portugal

Georg Fischer S.A.  
28046 Madrid  
Phone +34(0)91 781 98 90  
[es.ps@georgfischer.com](mailto:es.ps@georgfischer.com)  
[www.georgfischer.es](http://www.georgfischer.es)

### Sweden/Finland

Georg Fischer AB  
12523 Älvsjö-Stockholm  
Phone +46(0)8 506 775 00  
[info.se.ps@georgfischer.com](mailto:info.se.ps@georgfischer.com)  
[www.georgfischer.se](http://www.georgfischer.se)

### Switzerland

Georg Fischer  
Rohrleitungssysteme [Schweiz] AG  
8201 Schaffhausen  
Phone +41(0)52 631 30 26  
[ch.ps@georgfischer.com](mailto:ch.ps@georgfischer.com)  
[www.piping.georgfischer.ch](http://www.piping.georgfischer.ch)

### Taiwan

Georg Fischer Piping Systems  
San Chung City, Taipei Hsien  
Phone +886 2 8512 2822  
Fax +886 2 8512 2823

### United Kingdom/Ireland

Georg Fischer Sales Limited  
Coventry, CV2 2ST  
Phone +44(0)2476 535 535  
[uk.ps@georgfischer.com](mailto:uk.ps@georgfischer.com)  
[www.georgfischer.co.uk](http://www.georgfischer.co.uk)

### USA/Latin America/Caribbean

Georg Fischer LLC  
Tustin, CA 92780-7258  
Phone +1(714) 731 88 00  
Toll Free 800 854 40 90  
[us.ps@georgfischer.com](mailto:us.ps@georgfischer.com)  
[www.us.piping.georgfischer.com](http://www.us.piping.georgfischer.com)